

Article number: 208050121

Description: E+G Sphericalwasher male DIN 6319-13-C-NI
Stainless Steel 1.4305

Measures

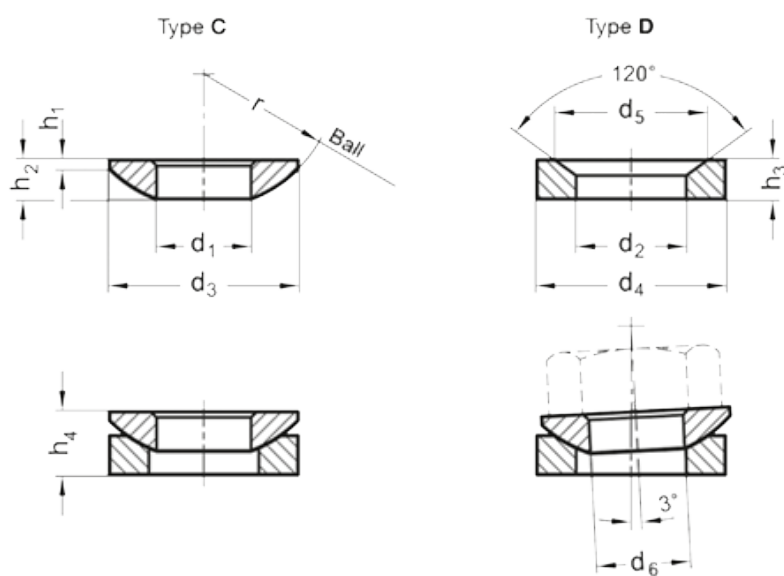

$d_1 = 13.0$

$d_3 = 24$

$d_6 = M12$

$H_1 = 1.1$

$H_2 = 4.6$

$H_4 = 8.0$

$r = 17$